

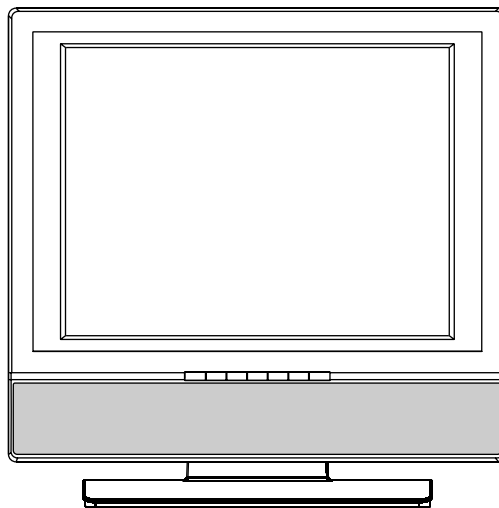

FPE1507

15" FLAT PANEL LCD TV



OWNER'S MANUAL

FOR ASSISTANCE CALL CUSTOMER SERVICE AT 1-800-645-4994
OR VISIT US AT WWW.AUDIOVOX.COM

128-8059

PLV1615CS1 / AUDIOVOX / ENGLISH
SIZE: 148 X 210 MM
MATERIAL: 80G WOODFREE PAPER
100%
19-04-2007

Printed in China
811-161S91W220

SAFETY PRECAUTIONS



* SEE REAR OF UNIT FOR GRAPHIC SYMBOLS *



The lightning flash with an arrowhead within a triangle alerts you to uninsulated dangerous voltage within the product's enclosure that could cause an electric shock.



The exclamation point within a triangle alerts you to the presence of important operating, maintenance, and servicing instructions in this user's manual.

WARNING: TO REDUCE THE RISK OF ELECTRIC SHOCK, DO NOT REMOVE COVER (OR BACK). NO USER-SERVICEABLE PARTS INSIDE. REFER SERVICING TO QUALIFIED PERSONNEL.

WARNING: TO PREVENT FIRE OR SHOCK HAZARD, DO NOT EXPOSE THIS UNIT TO RAIN OR MOISTURE. DO NOT PLACE OBJECTS FILLED WITH LIQUIDS ON OR NEAR THIS UNIT.

CAUTION: DANGER OF EXPLOSION IF BATTERY IS INCORRECTLY REPLACED. REPLACE ONLY WITH THE SAME OR EQUIVALENT TYPE.



The symbol for Class II (Double Insulation)

PLACEMENT INFORMATION

- Do not use this unit in places which are extremely hot, cold, dusty, or humid.
- Do not restrict the air flow of this unit by placing it somewhere with poor air flow, by covering it with a cloth, or by placing it on bedding or carpeting.

SAFETY INFORMATION

- When connecting or disconnecting the AC cord, grip the plug and not the cord itself. Pulling the cord may damage it and create a hazard.
- When you are not going to use the unit for a long period of time, disconnect the AC cord.

CONDENSATION INFORMATION

- When left in a heated room where it is warm and damp, water droplets or condensation may form inside the unit. When there is condensation inside the unit, the unit may not function normally. Let the unit stand for 1-2 hours before turning the power on, or gradually heat the room and let the unit dry before use.

FCC INFORMATION

WARNING: Changes or modifications to this unit not expressly approved by the party responsible for compliance could avoid the user authority to operate the equipment.

NOTE: This equipment has been tested and found to comply with the limits for a Class B digital device, pursuant to part 15 of the FCC Rules. These limits are designed to provide reasonable protection against harmful interference in a residential installation. This equipment generates, used in accordance with the instructions, may cause harmful interference to radio communications. However, there is no guarantee that interference will not occur in a particular installation. If this equipment does cause harmful interference to radio or television reception, which can be determined by turning the equipment off and on, the user is encouraged to try to correct the interference by one or more of the following measures:

- Reorient or relocate the receiving antenna.
- Increase the separation between the equipment and receiver.
- Connect the equipment into an outlet on a circuit different from that to which the receiver is connected.
- Consult the dealer or an experienced radio/TV technician for help.

Shielded cables must be used with this unit to ensure compliance with the Class FCC limits.

WARNING: Should any problems occur, disconnect the AC cord and refer servicing to a qualified technician.

IMPORTANT SAFETY INSTRUCTIONS

1. Read these instructions.
2. Keep these instructions.
3. Heed all warnings.
4. Follow all instructions.
5. Do not use this apparatus near water.
6. Clean only with a dry cloth.
7. Do not block any ventilation openings. Install in accordance with the manufacturer's instructions.
8. Do not install near any heat sources such as radiators, heat registers, stoves, or other apparatus (including amplifiers) that produce heat.
9. Do not defeat the safety purpose of the polarized or grounding-type plug. A polarized plug has two blades with one wider than the other. A grounding type plug has two blades and a third grounding prong. The wide blade or the third prong are provided for your safety. If the provided plug does not fit into your outlet, consult an electrician for replacement of the obsolete outlet.
10. Protect the power cord from being walked on or pinched particularly at plug, convenience receptacles, and the point where they exit from the apparatus.
11. Only use attachments/accessories specified by the manufacture.
12. Use only with the cart, stand, tripod, bracket, or table specified by the manufacturer, or sold with the apparatus.  When a cart is used, use caution when moving the cart/apparatus combination to avoid injury from tip-over.
13. Unplug this apparatus during lightning storms or when unused for long periods of time.
14. Refer all servicing to qualified service personnel. Servicing is required when the apparatus has been damaged in any way, such as power-supply cord or plug is damaged, liquid has been spilled or objects have fallen into the apparatus, the apparatus has been exposed to rain or moisture, does not operate normally, or has been dropped.

TABLE OF CONTENTS

SAFETY PRECAUTIONS	2
IMPORTANT SAFETY INSTRUCTIONS	3
REMOTE CONTROL	5
ACCESSORIES	5
REMOTE CONTROL REFERENCE GUIDE	6
UNIT REFERENCE GUIDE	7
CONNECTIONS	8 – 13
Connecting a TV Antenna/Cable/Satellite	8
Connecting an A/V Device (VCR, PVR Camcorder, Game System, etc.) ...	9 – 11
Connecting a High-Definition (HD) Source	12
Connecting a PC	12
Connecting an Audio Amplifier	13
Connecting the Power Cord	13
INSTALLATION	14
Removing the Base Stand	14
Mounting on the Wall	14
USING HEADPHONES	15
UNIT OPERATION	15
Turning the Unit on for the First Time	15
TV SETUP	16 – 21
Video Menu	16
<i>VGA Settings in PC Mode</i>	17
Audio Menu	17
TV Menu	18
Setup Menu	18 – 20
<i>Time Setup Setting</i>	19
<i>Caption Setting</i>	20
<i>Restore Setting</i>	20
Parental Menu	20 – 21
<i>Password</i>	20
<i>Parental Control Setting</i>	21
TROUBLE SHOOTING GUIDE	22

REMOTE CONTROL

USING THE REMOTE CONTROL

- Point the remote control at the REMOTE SENSOR located on the unit.
- When using this unit in very bright light, the infrared REMOTE CONTROL SENSOR may not work properly.
- The recommended effective distance for using the remote control is about 16 feet (5 meters).

TO CHANGE THE REMOTE CONTROL BATTERY

1. Open the battery door.
2. Insert two "AAA" batteries.

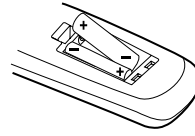
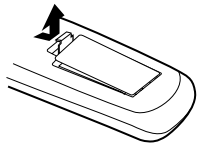

BATTERY REPLACEMENT

When the batteries become weak, the operating distance of the remote control will be greatly reduced and you will need to replace the batteries.

- Note:**
- If the Remote Control is not going to be used for a long time, remove the batteries to avoid damage caused by battery leakage corrosion.
 - Do not mix old and new batteries. Do not mix ALKALINE, standard (CARBON-ZINC) or rechargeable (NICKEL-CADMIUM) batteries.



WARNING: Do not dispose of batteries in a fire or they may leak and/or explode.

Many universal remote controls have a "learning" feature, we recommend you use that feature to program the remote control.

For any questions or problems related to programming a universal remote control, you must contact the customer service department of the universal remote control manufacturer for assistance, or refer to the instructions included with the universal remote control. We cannot offer assistance in programming universal remote controls.

ACCESSORIES

PLEASE LOCATE THE INCLUDED ACCESSORIES.

- Remote control (with battery) x 1

Specifications and appearance are subject to change without notice.

REMOTE CONTROL REFERENCE GUIDE

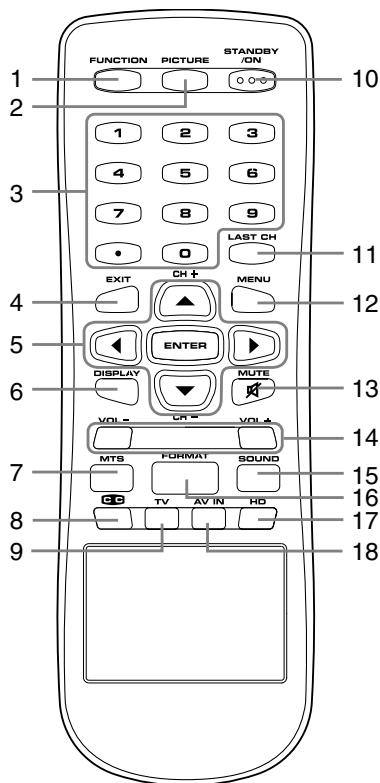

- 1) **FUNCTION Button**
Press to switch between TV / AV IN / YUV IN / PC IN.
- 2) **PICTURE Button**
Press to select from preset screen display settings to match the type of show you are watching (Standard, Dynamic, Personal, Soft & Movie)
- 3) **Number (0 - 9 and dot) Buttons**
In DVD mode, use when creating programs and locating a title/chapter or specific time.
In TV and other modes, use when inputting TV channel number and entering a parental control password.
DOT: Digital TV channels (ie 11.3 or 12.7)

- 4) **EXIT Button**
Press to return to previous menu or exit the menu and return directly to normal viewing.
- 5) **CURSOR (▼, ▲, ◀, ▶) Buttons**
Press to highlight selections on a menu screen and adjust certain settings.
ENTER Button
Press to confirm selections on a menu screen.
CH+/CH- Button
Press ▲/▼ to change the TV channels.
- 6) **DISPLAY Button**
Press to change disc status information displayed on the screen.
- 7) **MTS Button**
Press to select MONO sound, STEREO sound and Secondary Audio Program (SAP).
- 8) **CC Button**
Press to activate the Closed Captioning feature. This function only works on programs broadcasted with captions.
- 9) **TV Button**
Press to select TV channel mode.
- 10) **STANDBY/ON Button**
Press to turn ON the unit or put it in STANDBY (OFF) mode.
- 11) **LAST CH Button**
Press to switch repeatedly between the last two channels displayed.
- 12) **MENU Button**
Press to display the on-screen menu.
- 13) **MUTE Button**
Press to mute the sound. Press again to cancel mute.
- 14) **VOLUME (-/+) Buttons**
Press to adjust the volume level.
- 15) **SOUND Button**
Press to select from preset sound settings (Standard, Personal, Theater, Music, Voice) to match the type of show you are watching.
- 16) **FORMAT button**
Press to select the picture format.
- 17) **HD button**
Directly selects YUV IN (component video) mode.
- 18) **AV IN button**
Directly selects AV IN mode.

UNIT REFERENCE GUIDE

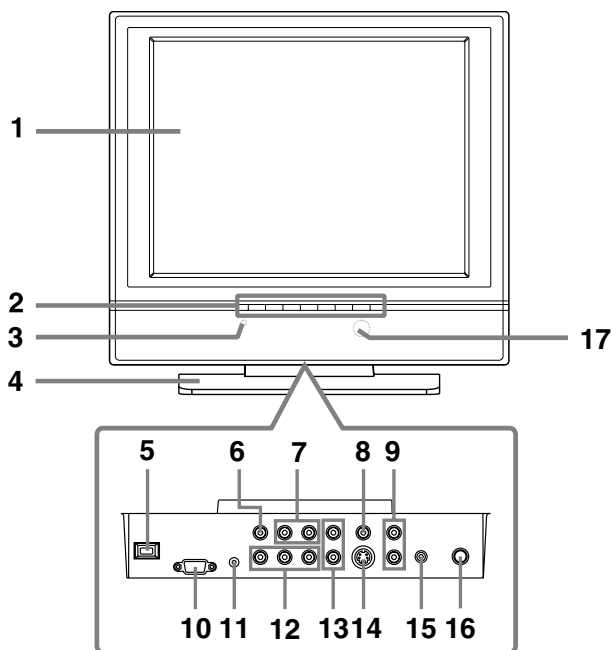

- | | |
|---|---|
| <p>1) Color LCD Screen</p> <p>2) STANDBY/ON Button
Turns the unit on and off.</p> <p>MENU Button
Enters and exits the TV menu.</p> <p>FUNCTION Button
Selects TV, AV IN, YUV IN or PC IN.</p> <p>- VOL + Controls
Adjusts the volume level and highlight selections (Left & Right) on the menu screen.</p> <p>▼/▲ Buttons
Selects a TV channel and highlight selections (Up & Down) on the menu screen.</p> <p>3) STANDBY Indicator
Indicates whether the unit is ON or in STANDBY (OFF) mode.
Light On: The unit is in STANDBY.
Light Off: The unit is turned ON.</p> | <p>4) Removable Base Stand</p> <p>5) Power Cord</p> <p>6) AV OUT Video Output Jack</p> <p>7) AV OUT Audio Output Jacks (Left/Right)</p> <p>8) AV IN Video Input Jack</p> <p>9) AV IN Audio Input Jacks (Left/Right)</p> <p>10) PC IN MONITOR/VGA Jack</p> <p>11) PC IN Audio Jack</p> <p>12) YUV IN Component Video Input Jacks (Y/PB/PR)</p> <p>13) YUV IN Audio Input Jacks (Left/Right)</p> <p>14) AV IN S-Video Input Jack</p> <p>15) Headphone Jack</p> <p>16) TV Antenna Cable Terminal - Coaxial TV Antenna Input</p> <p>17) REMOTE CONTROL SENSOR
Do not block this sensor or remote control will not work.</p> |
|---|---|

CONNECTIONS

CONNECTING A TV ANTENNA/CABLE/SATELLITE

To view television channels correctly, a signal must be received from one of the following sources:

- An indoor or outdoor aerial antenna
- A cable system
- A satellite system

Connecting a Digital Antenna

The tuner in this TV receives ATSC TV signals from an antenna.

This digital TV can receive standard (SDTV) and high definition (HDTV) over the air broadcasts.

Connecting an Analog Antenna or Device

The tuner in this TV can receive NTSC TV signals, analog cable signals or the RF output from a satellite receiver, VCR or cable box.

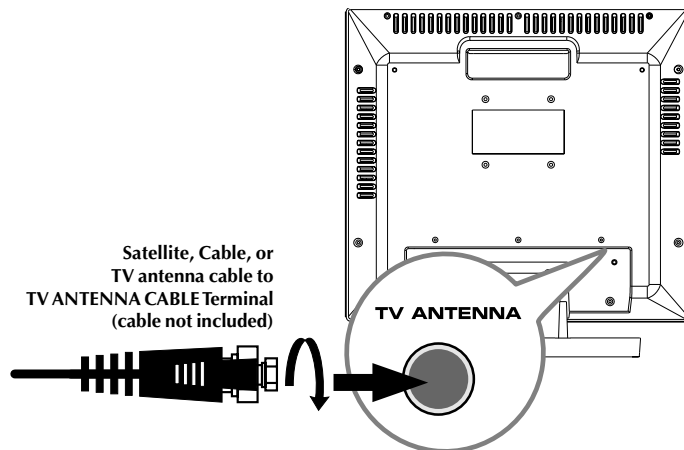

CONNECTIONS

CONNECTING TO A/V DEVICES (VCR, PVR, Camcorder, Game System, etc.)

Connecting to Devices with an S-Video Output

To connect to A/V devices such as a VCR or camcorder:

- Connect to a VCR

Connect the right (red) and left (white) audio output from the VCR to the right (red) and left (white) input on this unit (Audio cable not included).

Connect the S-VIDEO output from the VCR to the S-VIDEO input on this unit (S-VIDEO cable not included).

Make sure you connect both audio and video from the same VCR to the same input (AV IN).

Note:

Please refer to the user manual for the VCR for more information.

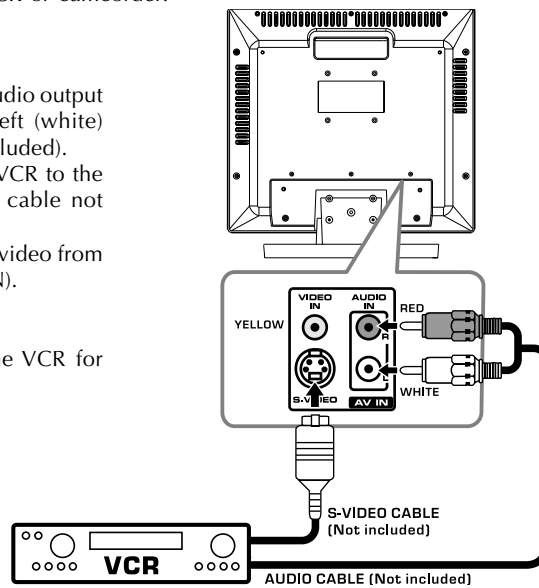

- Connect to a camcorder

Connect the right (red) and left (white) audio output from the camcorder to the right (red) and left (white) input on this unit (Audio cable not included).

Connect the S-VIDEO output from the camcorder to the S-VIDEO input on this unit (S-VIDEO cable not included).

Make sure you connect both audio and video from the same camcorder to the same input (AV IN).

Note:

Please refer to the user manual for the camcorder for more information.

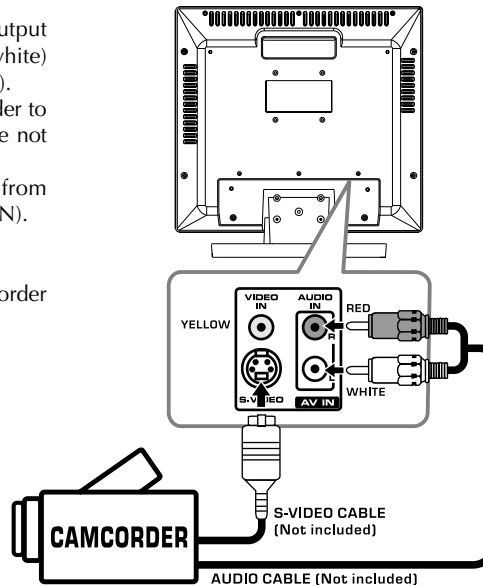

CONNECTIONS

Connecting to Devices with a Composite (yellow RCA-type) Video Output

To connect to A/V devices such as a VCR or camcorder:

- Connect to a VCR

Connect the right (red) and left (white) audio output from the VCR to the right (red) and left (white) input on this unit (Audio cable not included).

Connect the video (yellow) output from the VCR to the video input on this unit (Video cable not included).

Make sure you connect both audio and video from the same VCR to the same input (AV IN).

Note:

Please refer to the user manual for the VCR for more information.

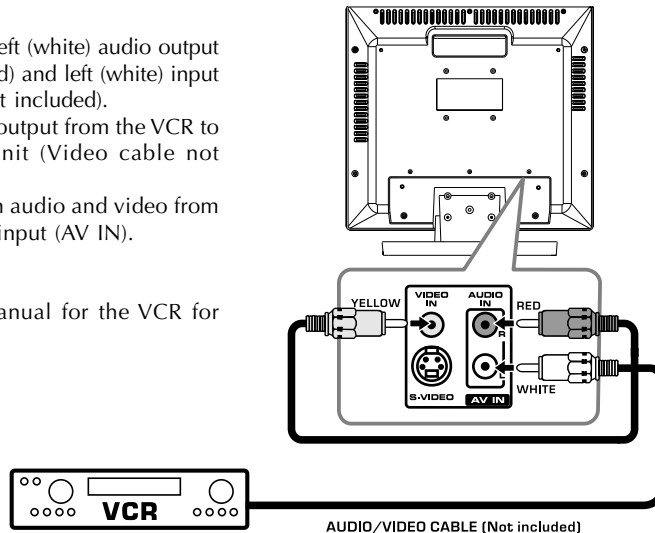

- Connect to a camcorder

Connect the right (red) and left (white) audio output from the camcorder to the right (red) and left (white) input on this unit (Audio cable not included).

Connect the video (yellow) output from the camcorder to the video input on this unit (Video cable not included).

Make sure you connect both audio and video from the same camcorder to the same input (AV IN).

Note:

Please refer to the user manual for the camcorder for more information.

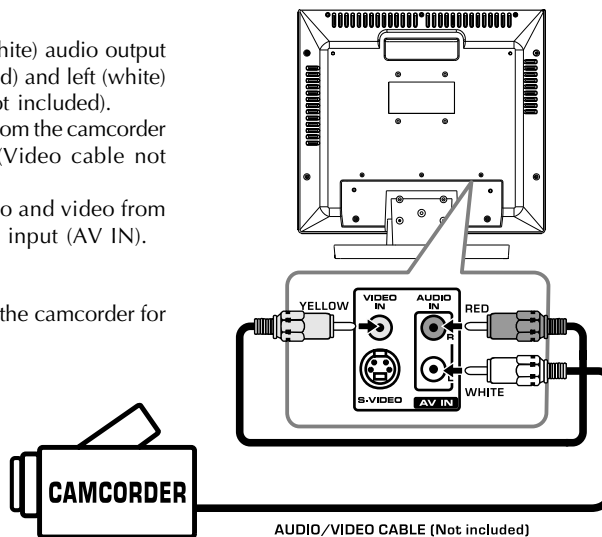

CONNECTIONS

Connecting to Devices with a Composite (yellow RCA-type) Video Input

To connect to A/V devices such as a VCR, PVR or camcorder:

- Connect to a VCR/PVR

Connect the right (red) and left (white) audio input from the VCR/PVR to the right (red) and left (white) output on this unit (Audio cable not included).

Connect the video (yellow) input from the VCR/PVR to the video output on this unit (Video cable not included).

Make sure you connect both audio and video from the same VCR/PVR to the same output (AV OUT).

Note:

Please refer to the user manual for the VCR/PVR for more information.

Note:

- After connection, please operate in TV/AV mode.
- For the reason of copyright protection, the result copy may has bad picture and/or sound.

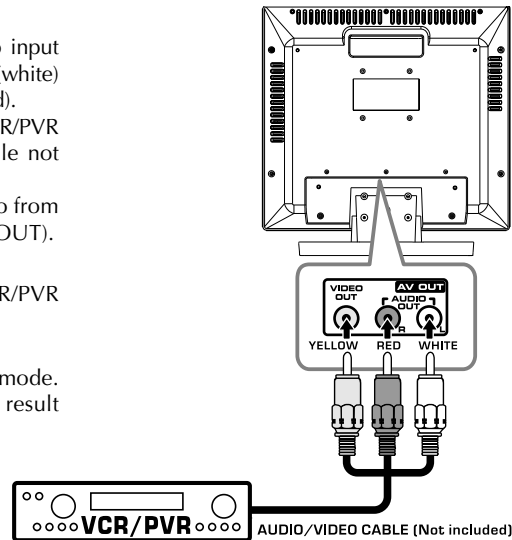

- Connect to a camcorder

Connect the right (red) and left (white) audio input from the camcorder to the right (red) and left (white) output on this unit (Audio cable not included).

Connect the video (yellow) input from the camcorder to the video output on this unit (Video cable not included).

Make sure you connect both audio and video from the same camcorder to the same output (AV OUT).

Note:

Please refer to the user manual for the camcorder for more information.

Note:

- After connection, please operate in TV/AV mode.
- For the reason of copyright protection, the result copy may has bad picture and/or sound.

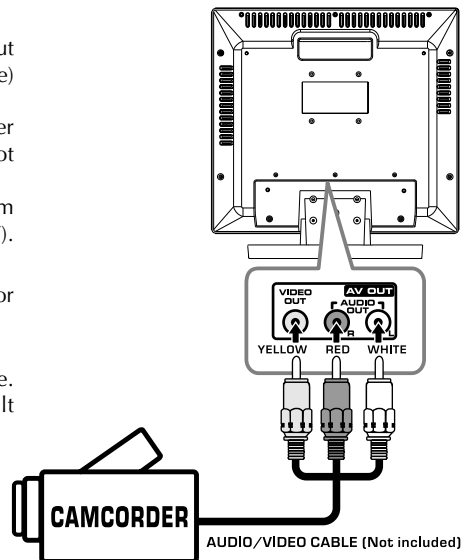

CONNECTIONS

CONNECTING A HIGH-DEFINITION (HD) SOURCE

High-Definition (HD) Devices with component video output must be connected to the YUV input.

Connect the three video outputs (Y, Pb, Pr) from the source to the corresponding video inputs on this unit (Component video cable not included).

Connect the right (red) and left (white) audio output from the source to the right (red) and left (white) input on this unit (Audio cable not included).

Make sure you connect both audio and video from the same source to YUV IN.

Note: When connecting a DVD player to the television, the picture resolution is solely dependent upon the resolution supported by the DVD player attached. DVD Player resolutions vary from 480i to 1080i, and this television can support DVD players up to a maximum resolution of 1080i.

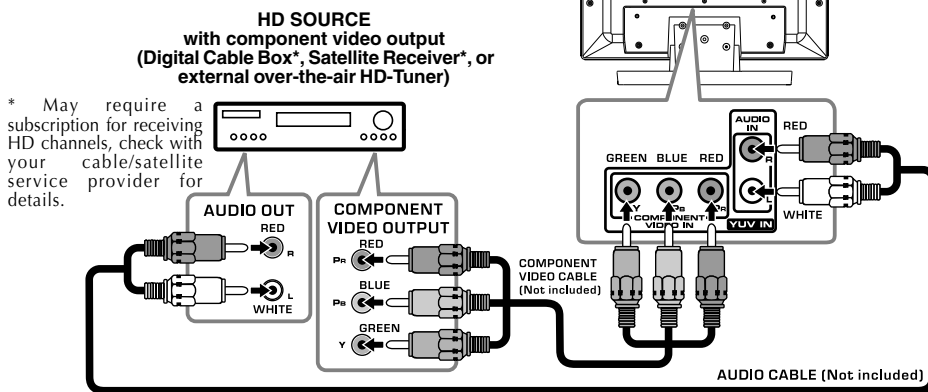

CONNECTING A PC

Connect the 15-pin D-SUB PC/VGA connector from your computer to the 15-pin D-SUB PC/VGA input on this unit using a monitor cable (not included). Connect a stereo audio cable (not included) to the PC AUDIO IN jack on this unit, and the other end to the AUDIO OUT jack on your computer's sound card.

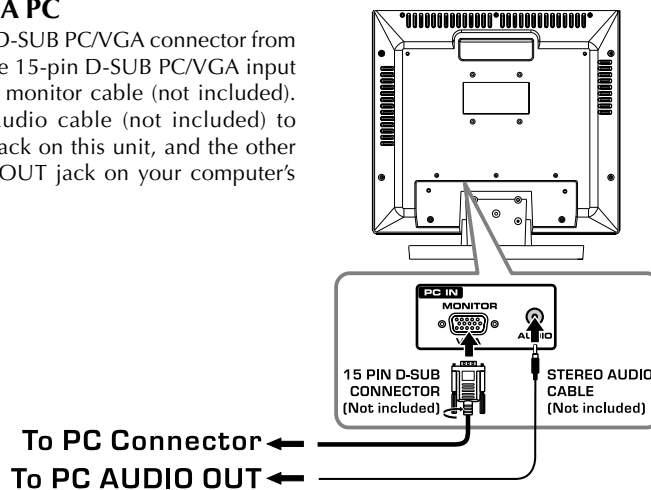

CONNECTIONS

CONNECTING AN AUDIO AMPLIFIER

This connection allows you to use an audio amplifier and external speakers.

Connect the right (red) and left (white) audio OUTPUT from this unit to the right (red) and left (white) audio INPUT on your amplifier. Refer to your amplifier's user manual for more information.

Note:

To control the audio, both the TV and the amplifier must be turned on, and the volume of the amplifier must be set above 0, or you will not hear any sound.

If you want to hear the sound from the amplifier only, press the **VOL –** button on the TV to decrease the volume or press the **MUTE** button on the remote control to turn off the sound.

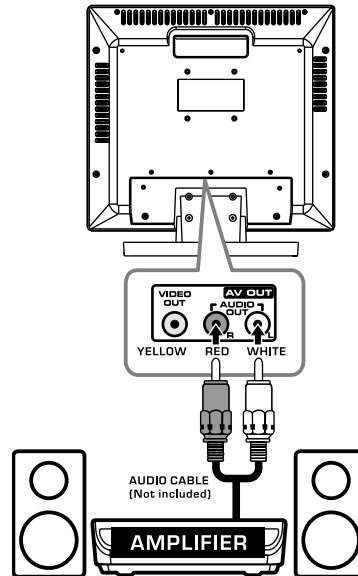

CONNECT THE POWER CORD

- Connect the AC power cord into a wall outlet.
- Press the **STANDBY/ON** button on the unit or remote control to turn on the unit.

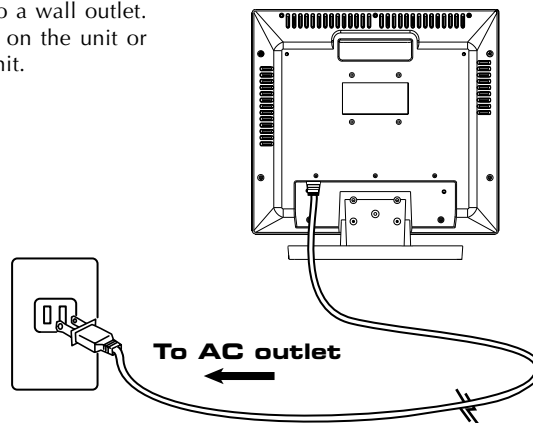

Note:

- Be sure the AC power cord is disconnected and all functions are off before making connections.
- Make sure that all the components are connected correctly.
- **To prevent electrical shock, match wide blade of plug to wide slot of wall outlet, then fully insert.**
- When you are not going to use the unit for a long period of time, disconnect the power cord.

INSTALLATION

REMOVING THE BASE STAND

WARNING: The LCD Display is very fragile, and must be protected at all times when removing the base stand. Be sure that no hard or sharp, or anything that could scratch or damage the LCD display, come in contact with it. Do NOT place pressure on the front of the unit at any time because the screen could crack.

1. Disconnect any cables or cords connected to the unit.
2. Lay the unit down on a flat surface, so the back side is facing up, making sure to place a soft cushioned material (such as a pillow or thick piece of foam) beneath the screen.
3. Remove the four screws and then remove the BASE STAND from the unit.

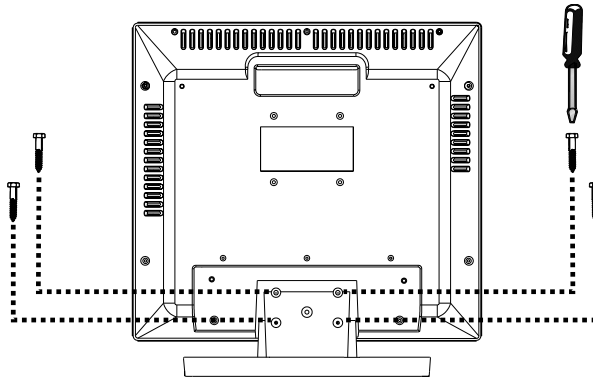

MOUNTING ON THE WALL

This unit is VESA-compliant, and is designed to be wall-mounted with a VESA-compliant 3" x 3" (75mm x 75mm) mounting kit designed for flat-panel TVs (sold separately). Mount this unit according to the directions included with the mounting kit.

Note: You must remove the base stand before mounting the unit on the wall.

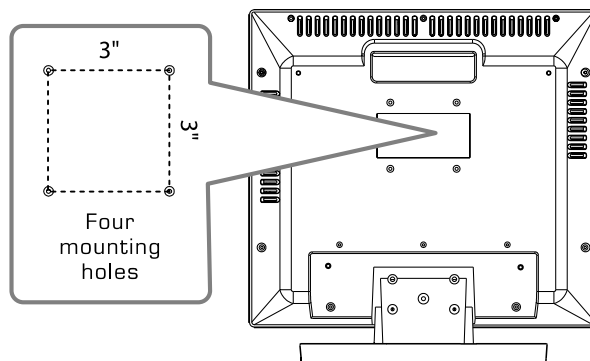

USING HEADPHONES

- Turn down the volume before connecting headphones to the unit, then adjust the volume to your desired level.
- When headphones are connected, no sound will come from the front speakers.

Note:

- Avoid listening to sound at high levels for prolonged periods of time. This may be harmful to you and may cause hearing loss.

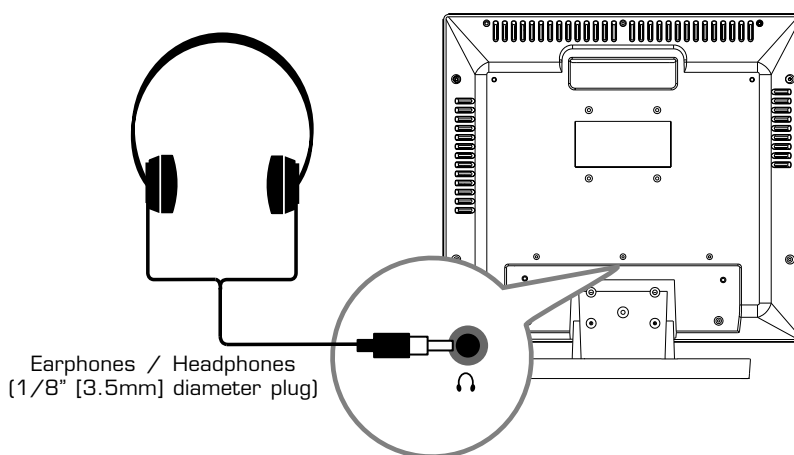

UNIT OPERATION

TURNING THE UNIT ON FOR THE FIRST TIME

The first time for you turning on the unit, the unit will enter Virgin mode. You can easily follow up prompt message on screen to finish basic settings of the system.

1. Press the **ENTER** button to proceed the **Initial Setup**.
2. Use the **▲ / ▼** button to select your OSD language, and press the **▶** button to the next step.
3. Use the **▲ / ▼** button to select your TV tuner source (Antenna or Cable), and press the **▶** button to the next step.
4. Make sure RF aerial has been connected properly to **TV ANTENNA** input jack on the rear of the system, press the **ENTER** or **▶** button. The system will automatically start to scan and preset all available TV channels.
5. After scanning finished, "Initial setup is Complete." will appear on the screen. Press the **ENTER** button to finish **Initial Setup**.

After finishing above settings, the system will return to the first TV channel scanned just now.

Note: When the unit is not going to be used for a long time, disconnect the AC power cord from AC power outlet.

TV SETUP

VIDEO MENU

1. Press the **MENU** button.
2. Press the **ENTER** or **▶** button to select **Video**.
3. Use the **▲** or **▼** button to select the options (**Picture Mode**, **Brightness**, **Contrast**, **Saturation**, **Tint**, **Sharpness** or **Color Temperature**). Adjust them using the **◀** or **▶** button (The screen will change to your desired setting); or press the **ENTER** or **▶** button to go into the detailed settings.
4. Press the **EXIT** button to return to the previous menu.
5. Repeat steps 3 and 4 to adjust other options.
6. To exit the **MAIN MENU** and return to the normal screen, press the **EXIT** button repeatedly.

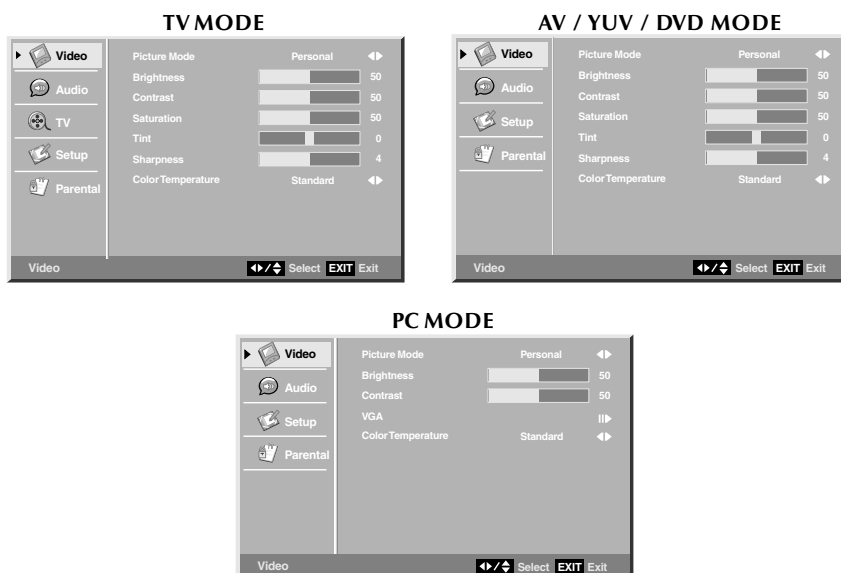

- **Picture Mode** : Select from preset screen display settings to match the type of show you are watching (Standard, Dynamic, Personal, Soft & Movie). (Select Personal mode to recall your customized settings on brightness, contrast, saturation, tint, sharpness and color temperature.)
- **Brightness** : Adjust the brightness of the picture. Brighten or darken the whole picture.
- **Contrast** : Adjust to sharpen the picture quality. The black portions of the picture become richer in darkness and the white become brighter.
- **Saturation** : Adjust the color saturation of the picture.
- **Tint** : Adjust the tint of the picture. (Toward purple / Toward green)
- **Sharpness** : Adjust the sharpness level to improve detail in the picture.
- **Color Temperature** : Adjust the three color temperature of the picture. Choose from Standard (balanced), Warm (red white), or Cool (blue white) modes.

TV SETUP

VGA Settings in PC Mode

Use the ▲ or ▼ button to select the options (**Auto Adjust**, **H. Position**, **V. Position**, **Phase** or **Clock**). Adjust them using the ◀ or ▶ button. The screen will change to your desired setting. (Press the ENTER or ▶ button to confirm Auto Adjust.)

- Resolution : 1,024 x 768 max
- Refresh Frequency : 60Hz max
- **H. Position** : Center the image by moving it left or right.
- **V. Position** : Center the image by moving it up or down.
- **Phase** : Adjusts the image if there is flicker of screen letters, color misalignment, or blurring.
- **Clock** : Adjusts the display clock to change width of the image.

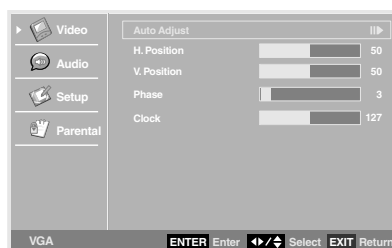

AUDIO MENU

1. Press the MENU button.
2. Use the ▲ or ▼ button to select **Audio**, then press the ENTER or ▶ button to go into the Audio settings.
3. Use the ▲ or ▼ button to select the options (**Balance**, **Bass**, **Treble** or **Audio Mode**). Adjust them using the ◀ or ▶ button (The screen will change to your desired setting); or press the ENTER or ▶ button to go into the detailed settings.
4. Press the EXIT button to return to the previous menu.
5. Repeat steps 3 and 4 to adjust other options.
6. To exit the MAIN MENU and return to the normal screen, press the EXIT button repeatedly.

TV MODE

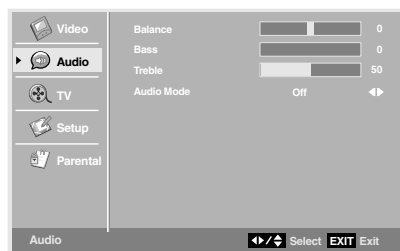

AV / YUV / DVD / PC MODE

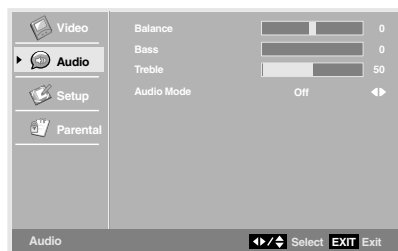

Note: Experiment with different sound settings until you find the settings you prefer.

- **Balance** : Adjust the balance level toward the left or right speakers.
- **Bass** : Adjust the bass range.
- **Treble** : Adjust the treble range.
- **Audio Mode** : Select from preset sound settings (Personal, Theater, Music, Voice, Standard) to match the type of show you are watching. (Select Personal mode to recall your customized settings on bass and treble.)

TV SETUP

TV MENU (For TV Mode Only)

1. Press the **MENU** button.
2. Use the **▲** or **▼** button to select **TV**. Press the **ENTER** or **▶** button to go into the TV settings.
3. Use the **▲** or **▼** button to select the options (**Tuner Mode**, **Auto Scan**, **Add Channel**, **Channel Skip**, **MTS** or **Audio Language**). Adjust them using the **◀** or **▶** button (The screen will change to your desired setting); or press the **ENTER** or **▶** button to go into the detailed settings.
4. Press the **EXIT** button to return to the previous menu.
5. Repeat steps 3 and 4 to adjust other options.
6. To exit the MAIN MENU and return to the normal screen, press the **EXIT** button repeatedly.

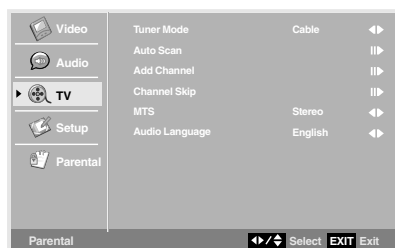

- **Tuner mode :** Antenna (over-the-air broadcasts) or Cable (cable/satellite broadcasts) mode are available.
- **Auto Scan Add CH:** Search for more usable stations and add them in memory. (The stations stored before are still kept.)
- **Add Channel:** Search for more usable stations and add them in memory.
- **Channel Skip:** Skip weak channels and the channels you don't like.
- **MTS:** Select Stereo / SAP (Secondary Audio Program) / Mono.
- **Audio Language:** Select from English / Spanish / French. (Available for digital channels if multiple audio languages are broadcasted.)

Note: The SAP (Secondary Audio Programs) feature allows a TV station to broadcast other information, which could be audio in another language.

Channel Skip Setting:

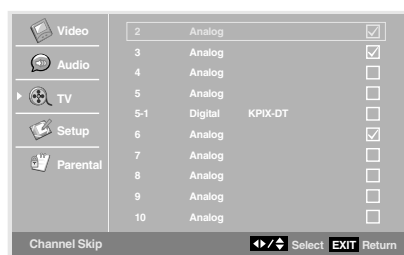

1. Use the **▲** or **▼** button to select a channel. (Press the **▶** button to select the last channel of the page, press again to the next page. Press the **◀** button to select the first channel of the page, press again to the previous page.)
2. Press the **ENTER** button to shift between skip or not skip the channel. ("✓" appears in the square means skip the selected channel. The channel will not appear when you press the **CH+/CH-** Button.)

SETUP MENU

1. Press the **MENU** button.
2. Use the **▲** or **▼** button to select **Setup**. Press the **ENTER** or **▶** button to go into the Setup settings.
3. Use the **▲** or **▼** button to select the options (**OSD Language**, **Time Setup**, **Caption** or **Restore setting**). Adjust them using the **◀** or **▶** button (The screen will change to your desired setting); or press the **ENTER** or **▶** button to go into the detailed settings.
4. Press the **EXIT** button to return to the previous menu.
5. Repeat steps 3 and 4 to adjust other options.
6. To exit the MAIN MENU and return to the normal screen, press the **EXIT** button repeatedly.

TV SETUP

TV MODE

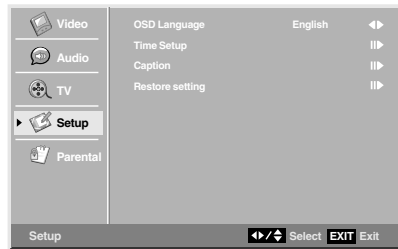

AV / YUV / DVD MODE

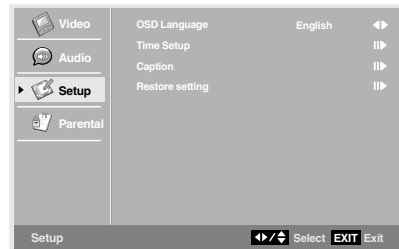

PC MODE

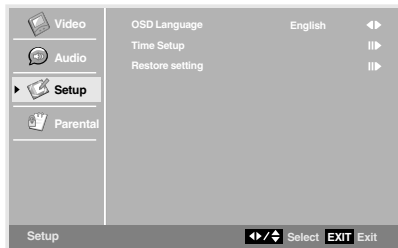

- **OSD Language** : Select from English / Español / Français.

Time Setup Setting:

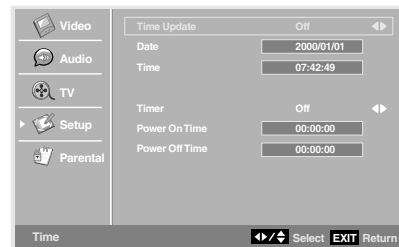
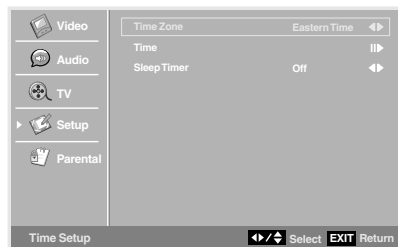

- **Time Zone** : Select the time zone from Eastern Time / Indiana / Central Time / Mountain Time / Arizona / Pacific Time / Aalaska / Hawaii.
- **Sleep Timer** : Select the time to turn the unit to Standby mode automatically: Off -> 5 Minutes -> 10 Minutes -> 15 Minutes -> 30 Minutes -> 60 Minutes -> 90 Minutes -> 120 Minutes -> Off.

When you set the 'Time', the option will be shown:

- **Time Update** : Select On/Off to activate the following manual settings; Select Auto to synchronize time with the digital TV channel signal.
- **Date** : Press the ◀ or ▶ button to locate the position, and press the number buttons to input date.
- **Time** : Press the ◀ or ▶ button to locate the position, and press the number buttons to input time.
- **Timer** : Select On to activate automatically power on/off.
- **Power On Time** : Press the ◀ or ▶ button to locate the position, and press the number buttons to input power on time.
- **Power Off Time** : Press the ◀ or ▶ button to locate the position, and press the number buttons to input power off time.

TV SETUP

Caption Setting:

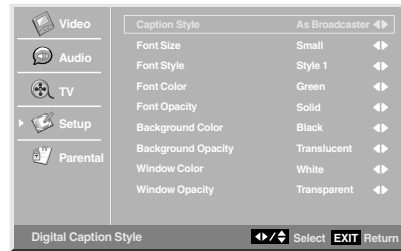
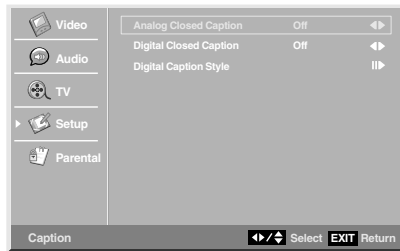

- **Analog Closed Caption** : Select the analog closed caption or turn it off.
- **Digital Closed Caption** : Select the digital closed caption or turn it off.
- **Digital Caption Style** : Select As Broadcaster to use the default digital caption style of the broadcaster. Select Custom to activate the caption style items and set your preferred detailed settings.

Note: This function only works on ATSC programs broadcast with captions.

Restore Setting:

If you reset the TV to the factory settings, all your present settings on Video & Audio will be erased and replaced by the factory's default settings. However, picture settings in PC mode and Parental settings will not be erased.

PARENTAL MENU

Password

1. Press the **MENU** button.
2. Use the **▲** or **▼** button to select **Parental**. Press the **ENTER** or **▶** button to confirm. The menu locked screen will be displayed.
3. Enter a 4-digit password. Once entered, the screen will enter the Parental menu. The preset password is 0000.

You can edit the parental control level or change the password. See **Parental Control Settings** on the next page.

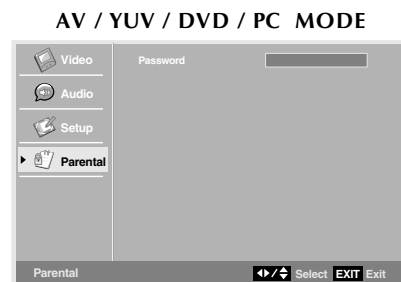
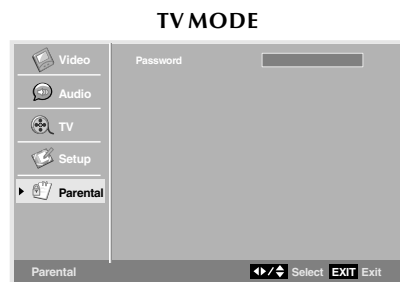

If you forget the password,
enter " 8888 " to unlock parental control.

TV SETUP

Parental Control Setting:

- Use the ▲ or ▼ button to select various Parental settings. Press the **ENTER** or ► button to go into the detailed settings.
- Use the ▲, ▼, ◀ and ▶ buttons to move among the rating levels. Press the **ENTER** button to change the mode between Blocked and Allowed.
- Press the **EXIT** button to return to the previous menu.
- Repeat steps 4 - 6 to adjust other options.
- To exit the MAIN MENU and return to the normal screen, press the **EXIT** button repeatedly.

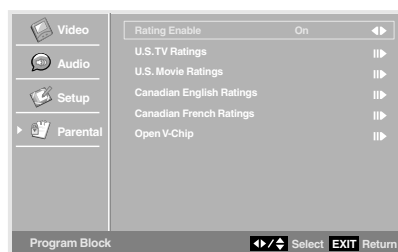
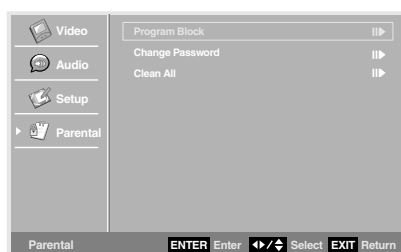

- Rating Enable** : Select On to edit the following parental items. Select Off to disable parental control.
- Open V-Chip** : Read the ratings from ATSC TV programs if there is rating information broadcasted, and denies the channel when its rating is higher than the ratings you pre-set.

U.S. TV Ratings	TV-Y : Recommended for all children. TV-Y7 : Recommended for all children age 7 and above. TV-G : General Audience. TV-PG : Parental Guidance Suggested. TV-14 : Parental Strongly Cautioned. TV-MA : Mature Audience Only.
U.S. Movie Ratings	G : GENERAL AUDIENCES, Suitable for all ages. PG : PARENTAL GUIDANCE SUGGESTED - Some material may not be suitable for children. PG-13 : PARENTS STRONGLY CAUTIONED - Some material may be inappropriate for children under 13. R : RESTRICTED, Under 17 requires accompanying parent or adult guardian for viewing in movie theaters. NC-17 : No one 17 or under admitted in movie theaters, X : Adults Only.
Canadian English Ratings	C : Children. C8+ : Recommended for children age 8 and older. G : GENERAL AUDIENCES, Suitable for all ages. PG : PARENTAL GUIDANCE SUGGESTED - Some material may not be suitable for children. 14+ : Viewers 14 years and older. 18+ : Adult Programming.
Canadian French Ratings	G : GENERAL AUDIENCES, Suitable for all ages. 8 ans+ : Not recommended for young children. 13 ans+ : Not suitable for children under the age of 13. 16 ans+ : Not suitable for children under the age of 16. 18 ans+ : Adult Programming.

TROUBLE SHOOTING GUIDE

SYMPTOM

CAUSE (AND REMEDY)

No power.

- Check that the AC power cord is connected.
- Turn on the unit.

The remote does not function.

- Remove any obstacles between the remote and the unit.
- Use the remote near the unit.
- Point the remote at the remote sensor on the unit.
- Replace the battery in the remote with a new one.

Bad Picture (snow, multiple images, distortion, blurry)

- Check the location of the antenna and adjust it if necessary.
- Make sure the antenna cable is connected firmly.
- Make sure all input cables are firmly connected.

No sound.

- Increase the volume.
- Check whether the mute function has been activated on the Remote Control.

Black and white picture.

- Check the Picture setting within the Setup menu.
- Check to make sure the program you are watching is broadcast in Color and not Black & White.

No picture or sound.

- Make sure the unit is plugged in and turned on.
- Make sure that the TV mode is selected.
- Try a new channel to check for possible station trouble.
- Make sure the antenna is connected properly.
- Increase the volume.
- Make sure the antenna or audio/video source device is working properly.
- Make sure all cables are connected firmly.
- Check for local interference.

Colored patches of picture.

- Make sure there are no unshielded electrical devices nearby that are causing interference.
- Turn the TV off for 30 minutes, then try it again.



Unit : INCH

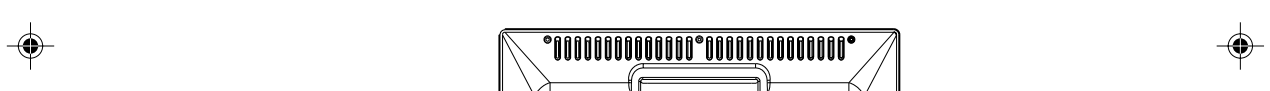
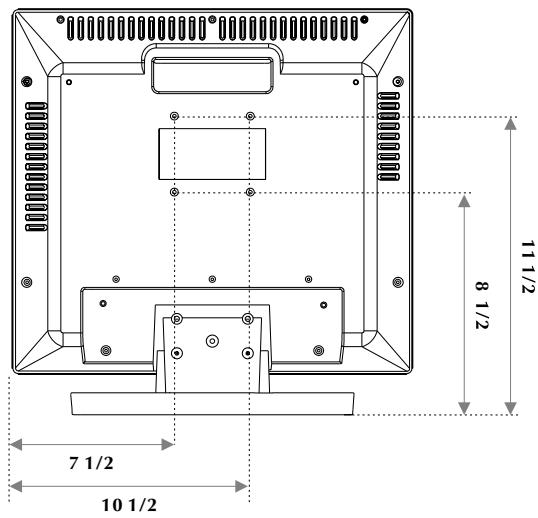
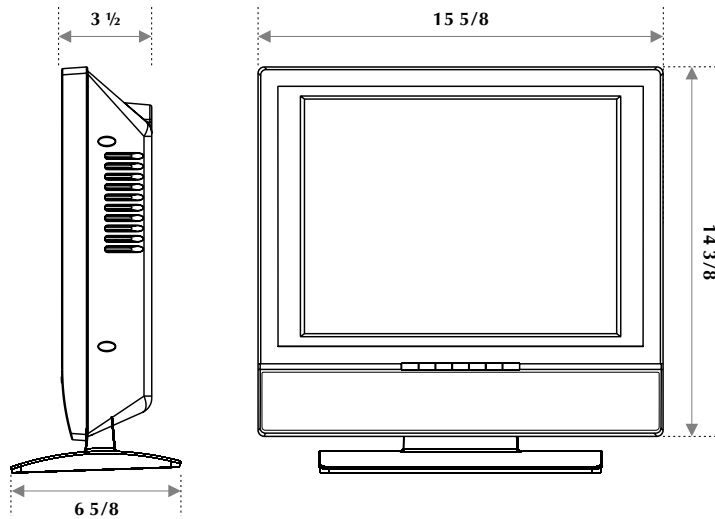

Printed in China
811-161S91W210

